

F · S · T



EN

DE

CN

ES

FR

INSTRUCTION MANUAL INTERCHANGEABLE MAGNIFIER HEADSET

FINE SCIENCE TOOLS

FEATURES & CONTENTS

FST® ITEM NO. 28080-10

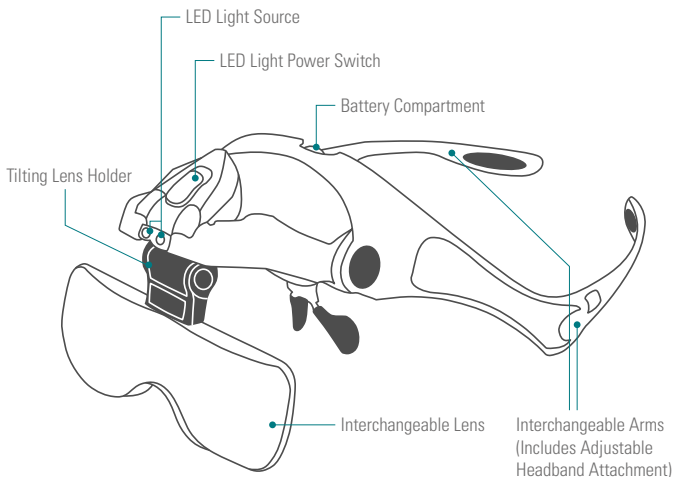

Microfiber
Cleaning Cloth

Interchangeable Lenses with Case
(5 Total Lenses Includes
1.0x, 1.5x, 2.0x, 2.5x, 3.5x)

Adjustable Headband
Attachment

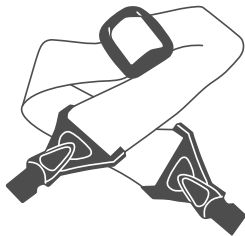
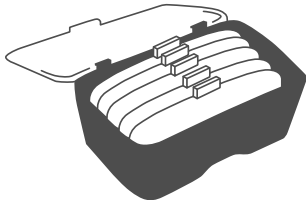

CHANGING THE BATTERIES

1. Remove the back panel **A** by pushing the tab **B**.

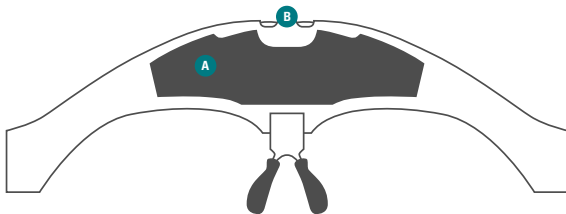

2. Insert 3 AAA batteries **C** and replace back panel.*

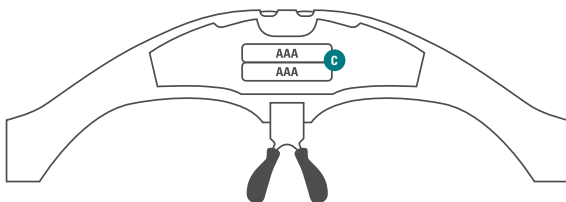

*Batteries Not Included

CHANGING LENSES

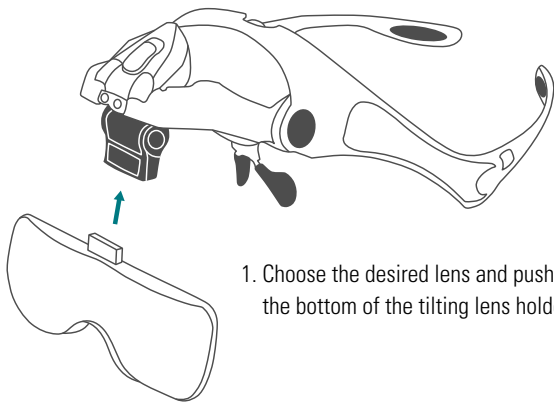

1. Choose the desired lens and push into the bottom of the tilting lens holder.

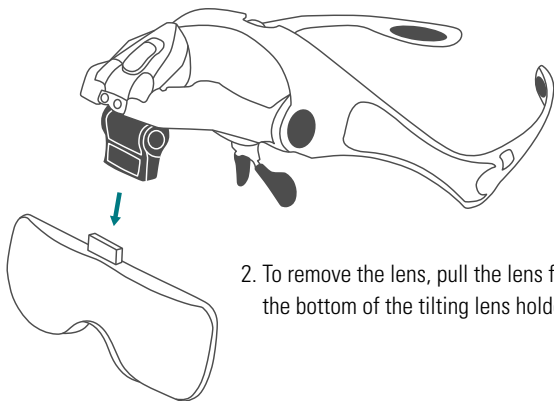

2. To remove the lens, pull the lens from the bottom of the tilting lens holder.

REPLACING THE ARMS WITH THE HEADBAND

1. Push the tab **A** located at the start of the arm. Pull the arm out while pushing the tab in.

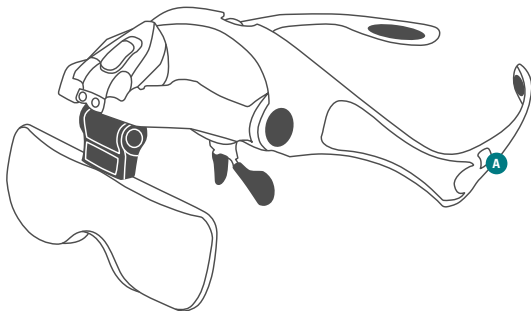

2. Insert the end of the headband into the tab **A**. The tab will click when fully inserted. Repeat step one to remove the headband.



F · S · T

F · S · T



EN

DE

CN

ES

FR

BEDIENUNGSANLEITUNG AUSTAUSCHBARES LUPEN-HEADSET

FINE SCIENCE TOOLS

MERKMALE UND INHALT

FST® ITEM NO. 28080-10

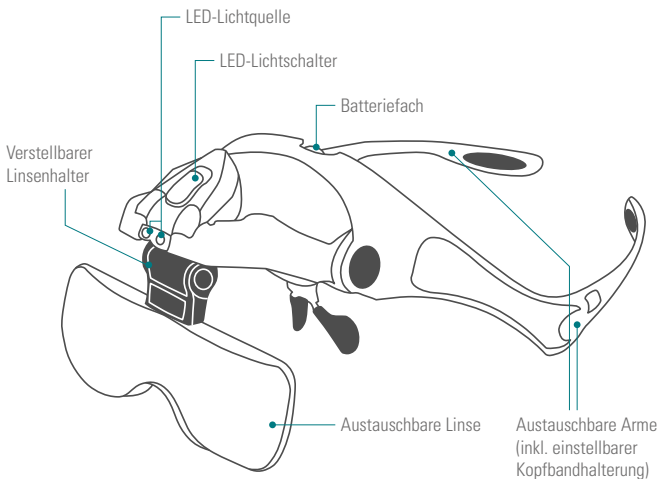

Mikrofaser-
Reinigungstuch

Wechsellinsen mit Etui
(5 Linsen insgesamt, inkl.
1,0x, 1,5x, 2,0x, 2,5x, 3,5x)

Verstellbare
Kopfbandhalterung

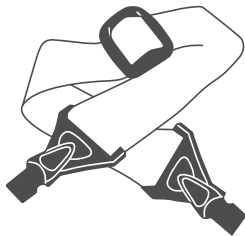
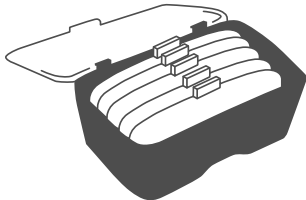

BATTERIEN WECHSELN

1. Entfernen Sie die hintere Abdeckung **A** indem Sie den Verschluss drücken. **B**.

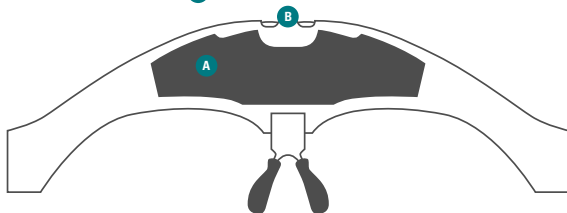

2. Legen Sie 3 AAA-Batterien ein **C** und bringen Sie die hintere Abdeckung wieder an.*

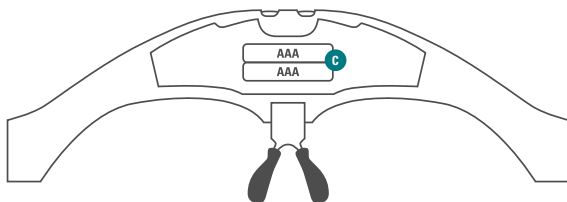

*Batterien nicht im Lieferumfang enthalten

LINSEN WECHSELN

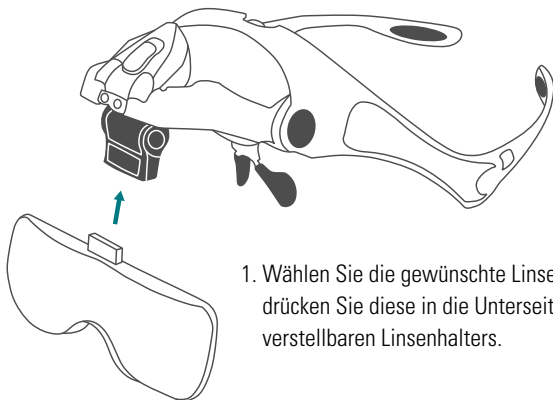

1. Wählen Sie die gewünschte Linse und drücken Sie diese in die Unterseite des verstellbaren Linsenhalters.

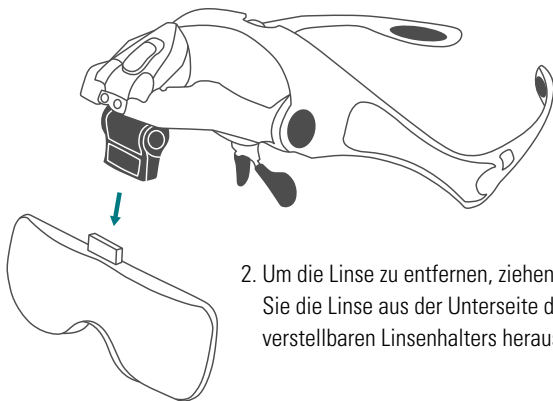

2. Um die Linse zu entfernen, ziehen Sie die Linse aus der Unterseite des verstellbaren Linsenhalters heraus.

ERSETZEN DER ARME DURCH DAS KOPFBAND

1. Drücken Sie das Befestigungselement, **A** das sich am Anfang des Arms befindet. Ziehen Sie den Arm heraus, während Sie die Lasche hineindrücken.

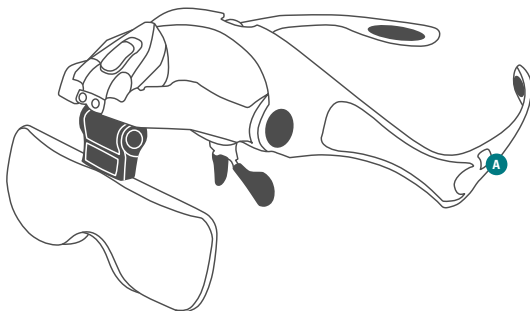

2. Führen Sie das Ende des Kopfbandes in das Befestigungselement **A** ein. Das Befestigungselement rastet ein, wenn es vollständig eingeführt ist. Wiederholen Sie Schritt 1, um das Kopfband zu entfernen.

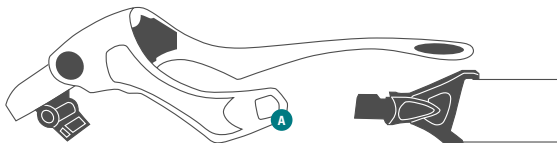

F · S · T

F · S · T



EN

DE

CN

ES

FR

可更换放大镜片头带使用 说明

FINE SCIENCE TOOLS

产品特性和配套配件

FST® 产品编号 28080-10

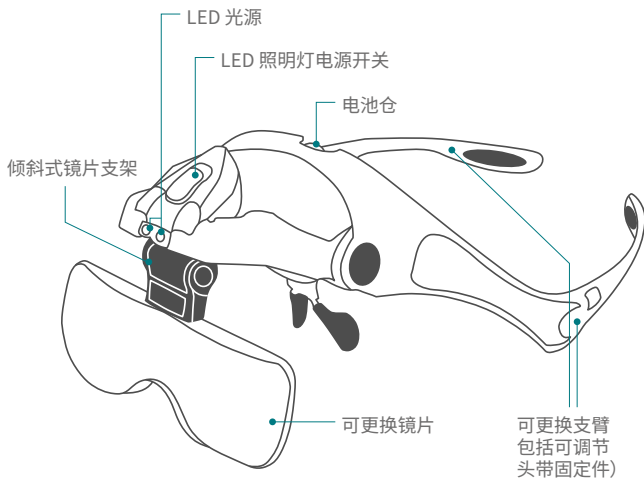

超细纤维清洁布

带收纳盒的可更换镜片
(共计 5 枚镜片, 包括
1.0x、1.5x、2.0x、2.5x、3.5x)

可调节头带固定件

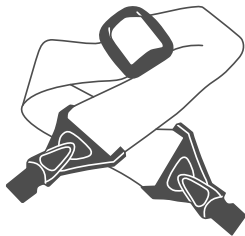
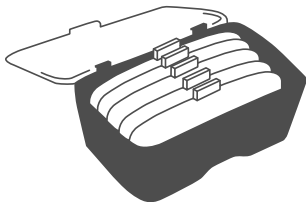
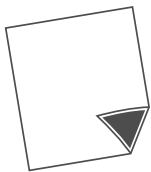

更换电池

1. 按压卡扣 **A**，拆下后面板 **B**。

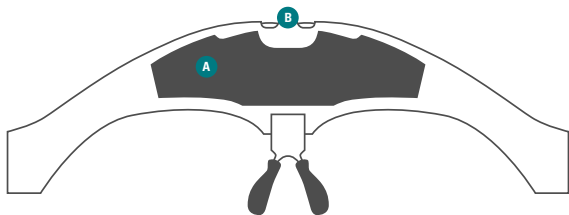

2. 插入 3 节 AAA 电池 **C**，装回后面板。*

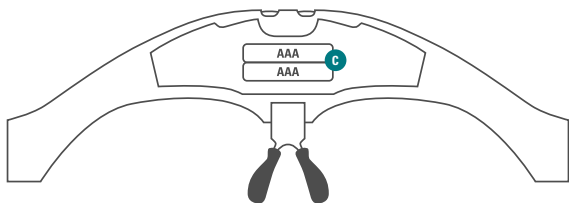

*不包含电池

更换镜片

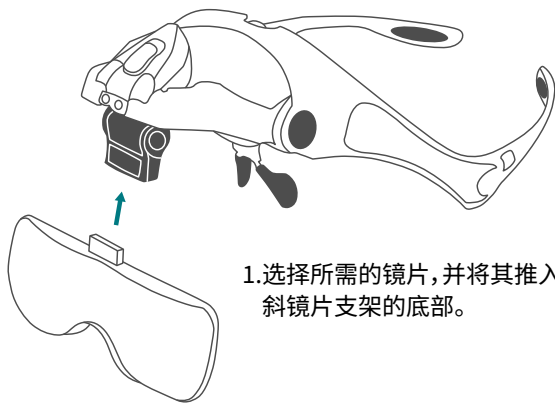

1. 选择所需的镜片，并将其推入可倾斜镜片支架的底部。

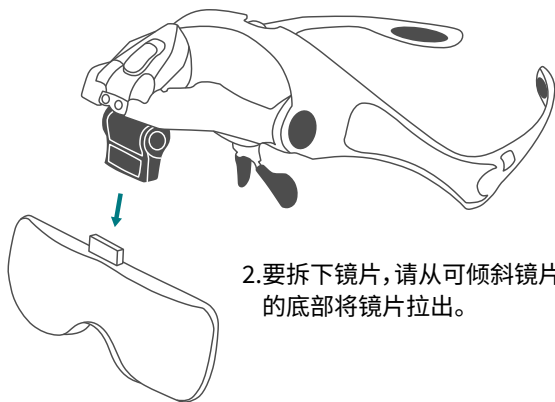

2. 要拆下镜片，请从可倾斜镜片支架的底部将镜片拉出。

将支臂更换为头带

1. 按下位于支臂前端的 **A** 卡扣。一边将卡扣推入，一边将支臂拉出。

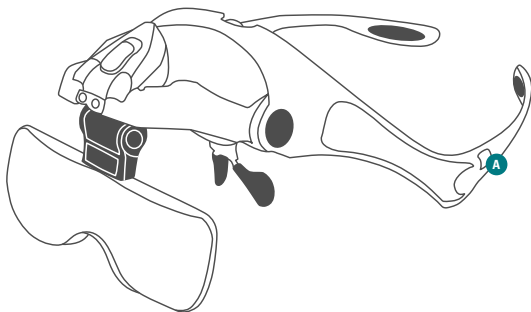

2. 将头带的一端插入卡扣中 **A**。完全插入后，卡扣会发出“咔嗒”声。重复步骤一，取下头带。

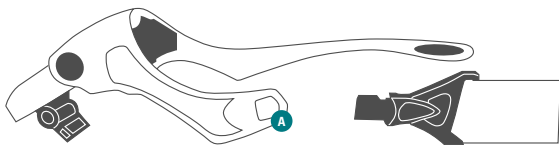

F · S · T

F · S · T



EN

DE

CN

ES

FR

MANUAL DE INSTRUCCIONES DE LA DIADEMA CON LUPA INTERCAMBIABLE

FINE SCIENCE TOOLS

CARACTERÍSTICAS Y CONTENIDO

FST® N.º DE ARTÍCULO 28080-10

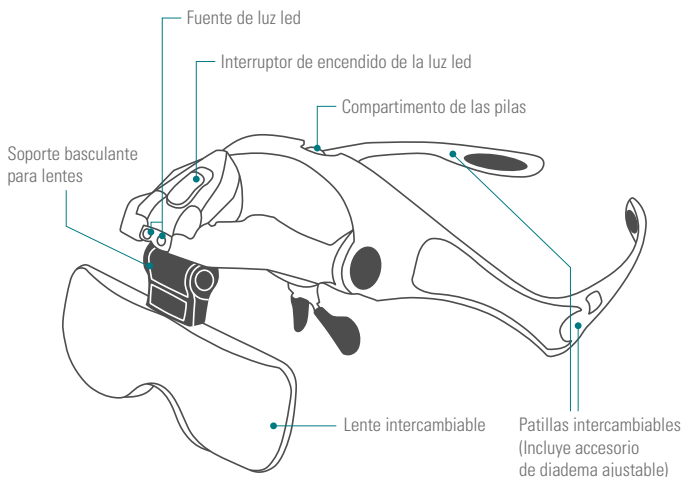

Paño de limpieza de microfibra

Lentes intercambiables con estuche (5 lentes en total, incluye 1,0x, 1,5x, 2,0x, 2,5x, 3,5x)

Accesorio de diadema ajustable

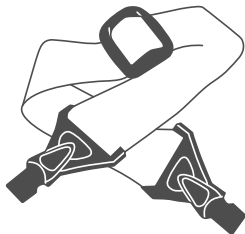
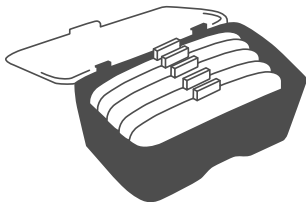

CAMBIO DE LAS PILAS

1. Retire el panel trasero **A** empujando la lengüeta **B**.

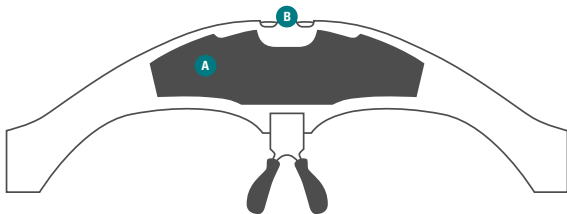

2. Introduzca 3 pilas AAA **C** y vuelva a colocar el panel trasero.*

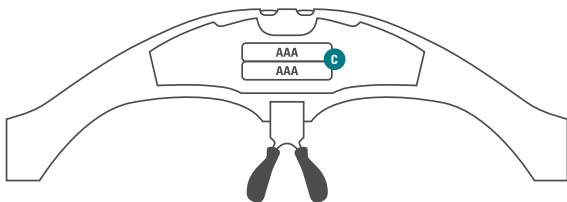

*Pilas no incluidas

CAMBIO DE LENTES

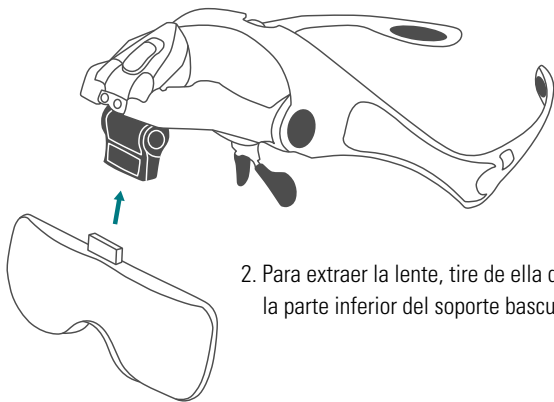

2. Para extraer la lente, tire de ella desde la parte inferior del soporte basculante.

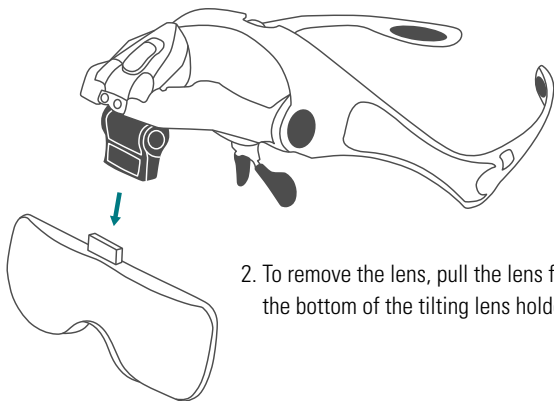

2. To remove the lens, pull the lens from the bottom of the tilting lens holder.

SUSTITUCIÓN DE LAS PATILLAS POR LA DIADEMA

1. Presione la lengüeta **A** situada al principio de la patilla. Tire de la patilla hacia fuera mientras presiona la lengüeta hacia dentro.

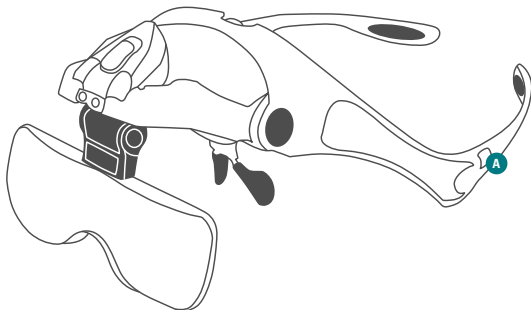

2. Introduzca el extremo de la diadema en la lengüeta **A**. Sonará un clic cuando la lengüeta esté completamente insertada. Repita el paso uno para retirar la diadema.



F · S · T

F · S · T



EN

DE

CN

ES

FR

MODE D'EMPLOI DU CASQUE AMPLIFICATEUR INTERCHANGEABLE

FINE SCIENCE TOOLS

CARACTÉRISTIQUES ET CONTENU

FST® RÉFÉRENCE 28080-10

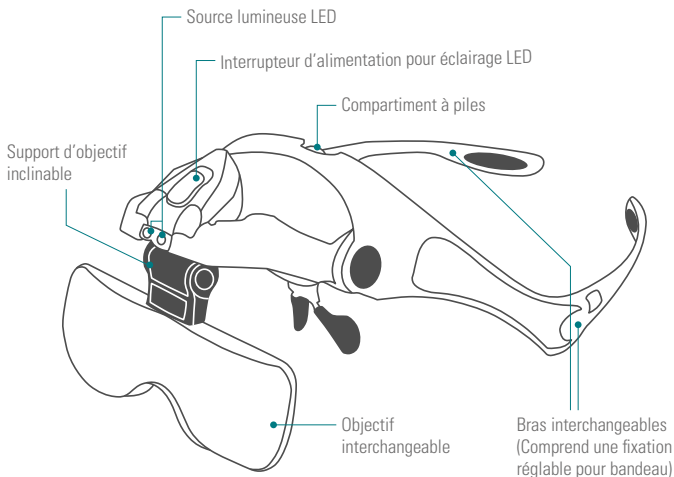

Chiffon de nettoyage en microfibre

Objectifs interchangeables avec étui (5 objectifs au total, dont : (1,0x, 1,5x, 2,0x, 2,5x, 3,5x))

Fixation réglable pour bandeau

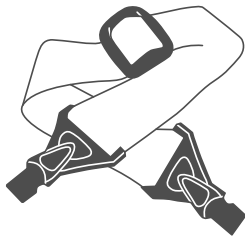
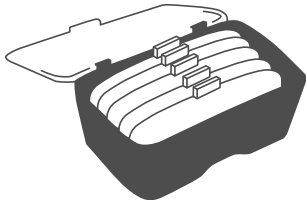

REPLACEMENT DES PILES

1. Retirez le panneau arrière **A** en appuyant sur la languette **B**.

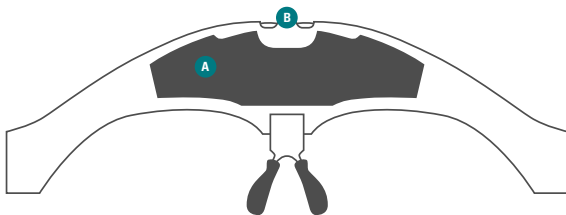

2. Insérez 3 piles AAA **C** et remettez le cache arrière en place.*

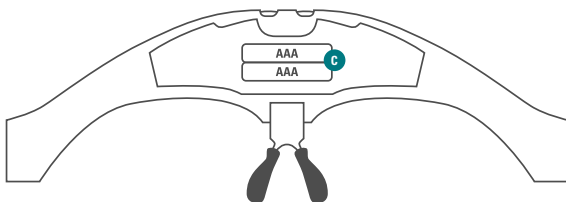

*Piles non fournies

CHANGER LES LENTILLES

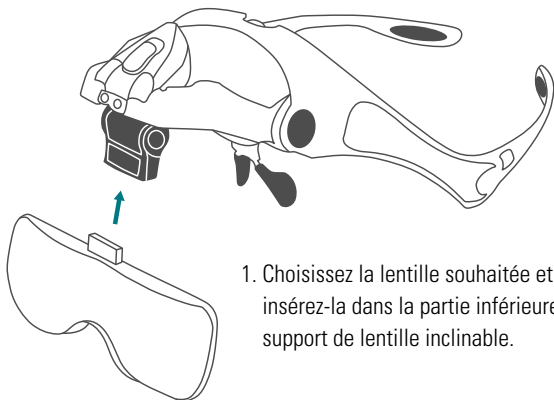

1. Choisissez la lentille souhaitée et insérez-la dans la partie inférieure du support de lentille inclinable.

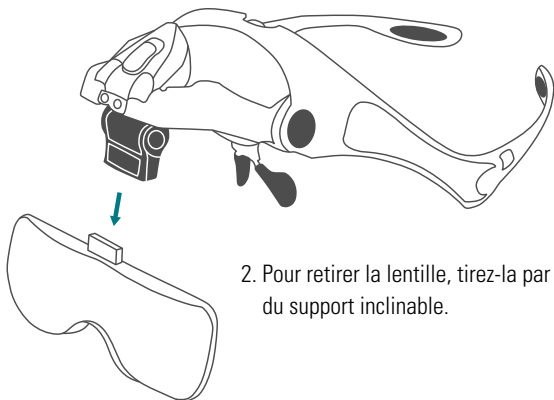

2. Pour retirer la lentille, tirez-la par le bas du support inclinable.

REEMPLACER LES BRAS PAR LE BANDEAU

1. Appuyez sur la languette **A** située au début du bras. Tirez sur le bras tout en enfonçant la languette.

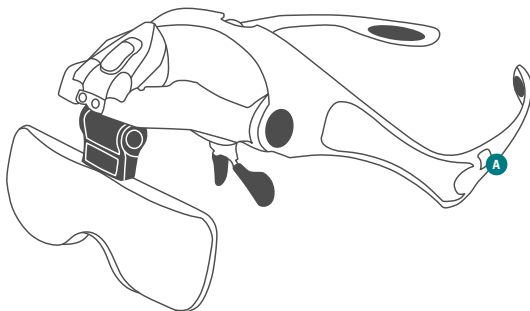

2. Insérez l'extrémité du bandeau dans la languette **A**. La languette émettra un clic lorsqu'elle sera complètement insérée. Répétez la première étape pour retirer le bandeau.



F · S · T